

Procedure Card

Section I: Sample Collection

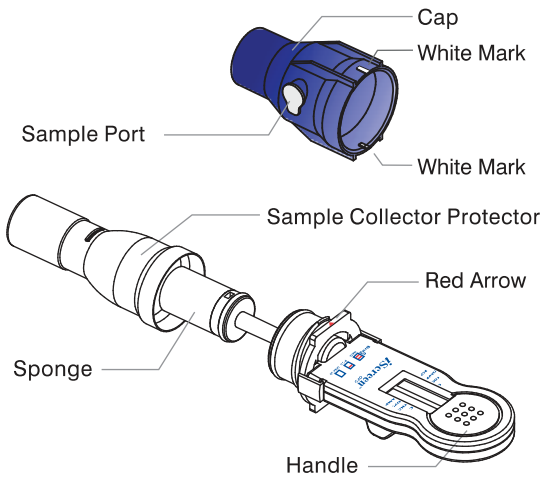

1. Instruct the donor not to place anything in the mouth including food, drink, gum or tobacco products for at least 10 minutes prior to collection.

2. Remove Sample Collector Protector.

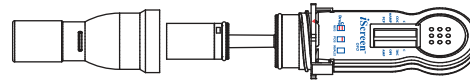

3. Insert Sponge end of collector into mouth. Actively swab the inside of the mouth and tongue with Sponge. As soon as the Sponge softens slightly, gently press the Sponge between the tongue and teeth to ensure **complete saturation**. The Sponge is saturated when no hard spots can be felt. Collect for at least three (3) minutes before removing Sponge. Hand the saturated collector over to the tester.

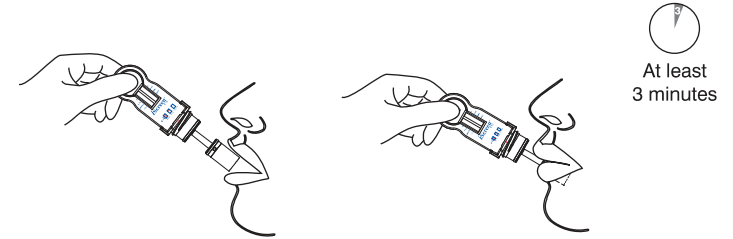

Section II: Testing

1. A. Align the Red Arrow on the device with either one of the **White Marks** on the Cap and **press down firmly until the Cap reaches the thread**. B. Twist the Handle clockwise 180° to tighten the Cap until the **Red Arrow** lines up with the other **White Mark**. C. Place the test device horizontally on a clean and level surface with the result window facing up.

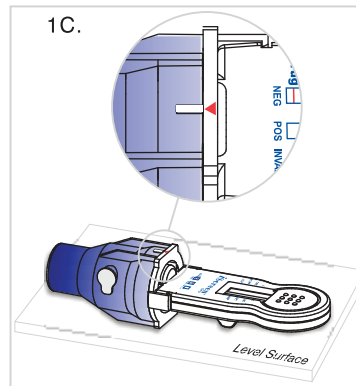
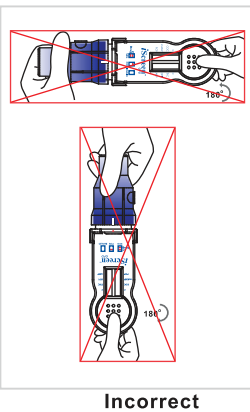
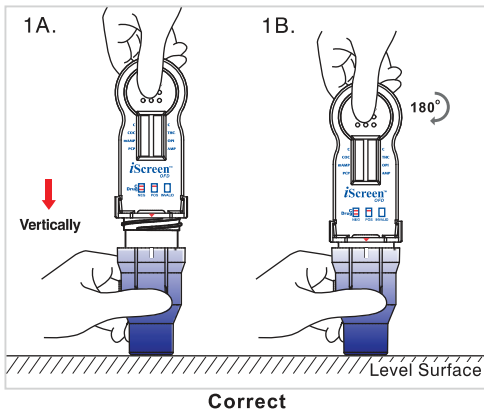

2. Read results at 10 minutes. Do not read results after 1 hour.

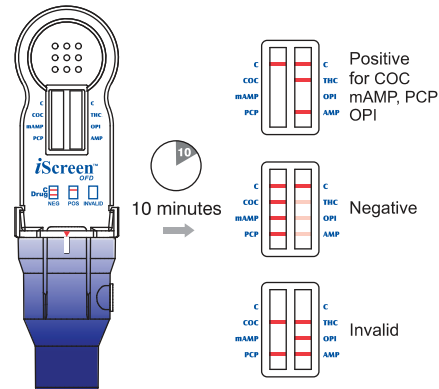

- All positive results are presumptive and should be confirmed by an alternate method. The preferred confirmatory method is GC/MS or GC/MS/MS.

3. If results are positive, secure Cap with Security Seal and send to laboratory for confirmation.

